

Muntin Grids – Historic Applications

Triple Grid



Series: Accessories Manufacturing Code: GR01

Drawing 1/2 Scale – For Custom Size Drawing Contact Graham

Note: Sealant Not Shown On Details. Refer To General Installation Instructions.

Standard Grids

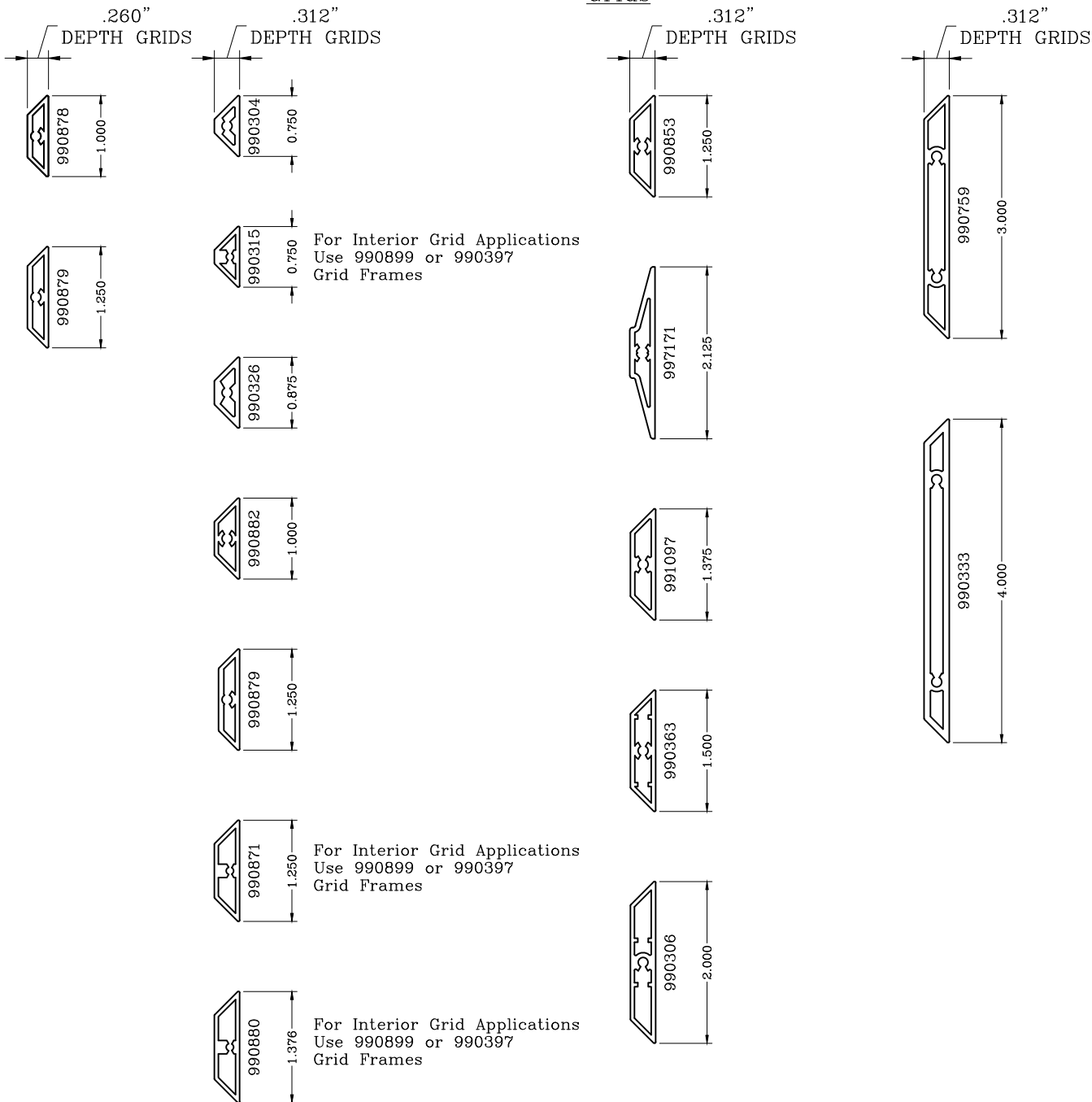

Graham Architectural Products reserves the right to change, add, cancel, remove or otherwise modify the details illustrated without prior notice.

1551 Mt. Rose Avenue, York, Pennsylvania 17403-2909 717.849.8100 Toll Free: 800/755-6274

0524 GR.01

Web Site: www.grahamwindows.com

Muntin Grids – Historic Applications

Triple Grid



Series: Accessories Manufacturing Code: GR02

Drawing 1/2 Scale – For Custom Size Drawing Contact Graham

Note: Sealant Not Shown On Details. Refer To General Installation Instructions.

Tubular Grids

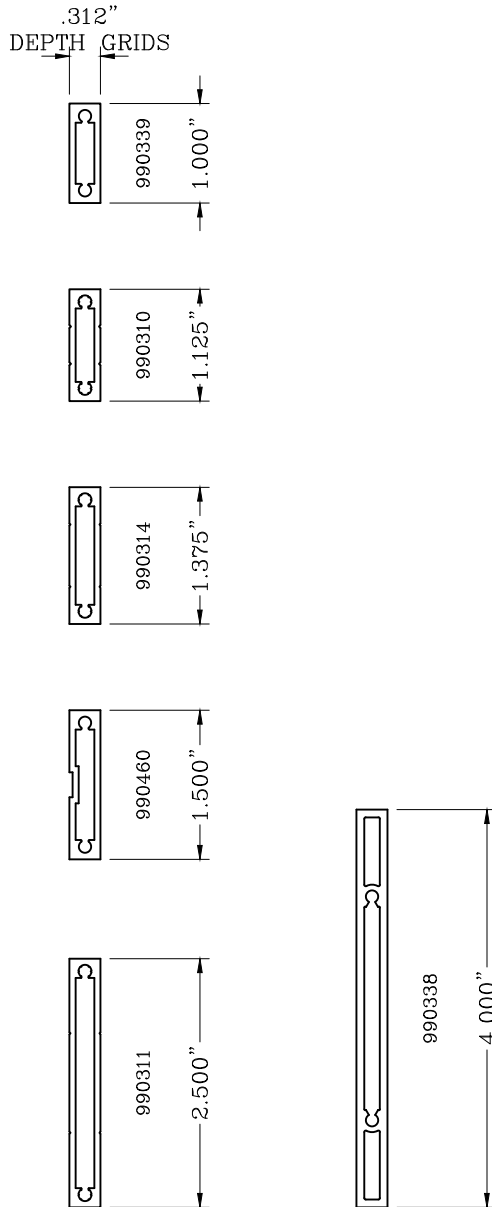

Profile Grids

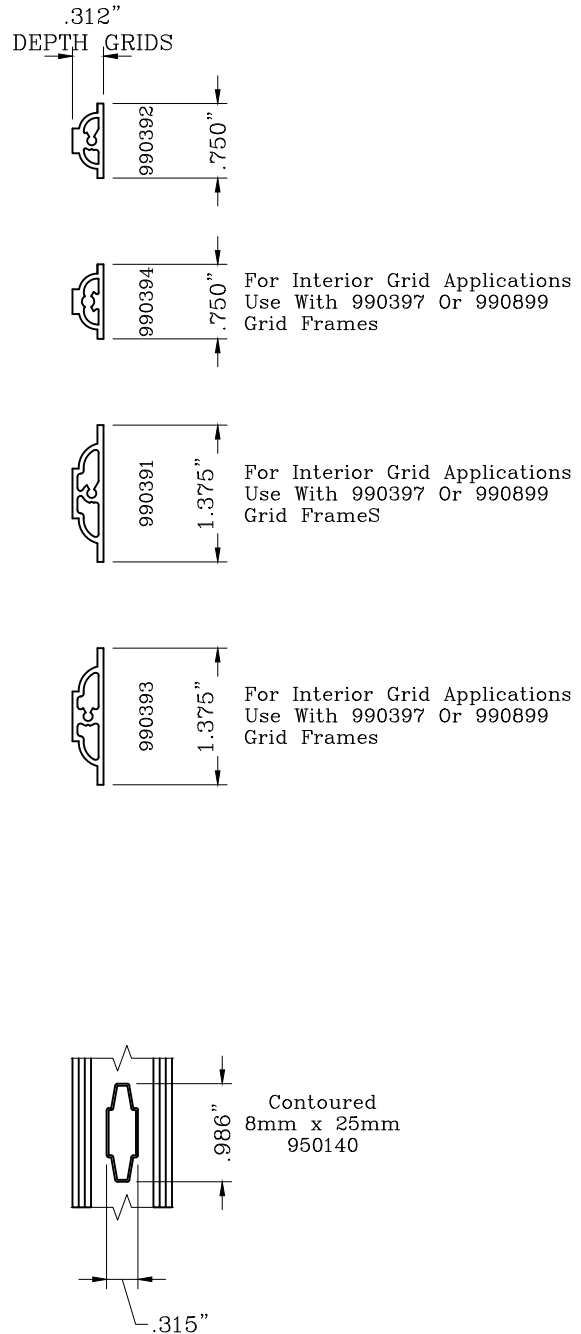

Graham Architectural Products reserves the right to change, add, cancel, remove or otherwise modify the details illustrated without prior notice.

1551 Mt. Rose Avenue, York, Pennsylvania 17403-2909 717.849.8100 Toll Free: 800/755-6274

0524 – GR.02

Web Site: www.grahamwindows.com

Muntin Grids – Historic Applications

Triple Grid



Series: Accessories Manufacturing Code: GR03

Drawing 1/2 Scale – For Custom Size Drawing Contact Graham

Note: Sealant Not Shown On Details. Refer To General Installation Instructions.

Standard Beveled Grids

GT6... Series With
Bevel Glazing Leg

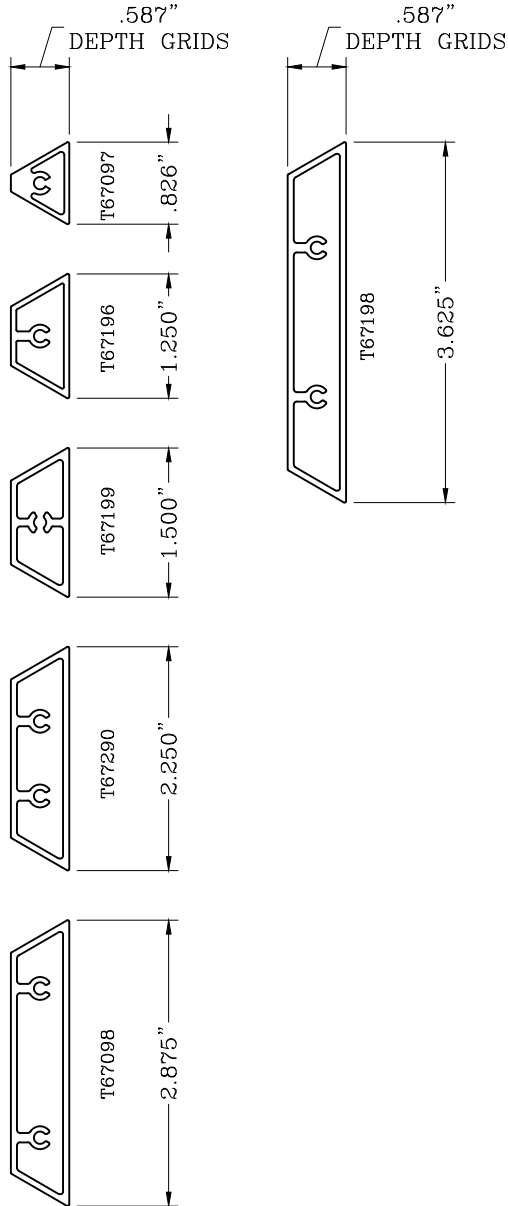

Standard Beveled Grids

SR67... Series With
Bevel Glazing Leg

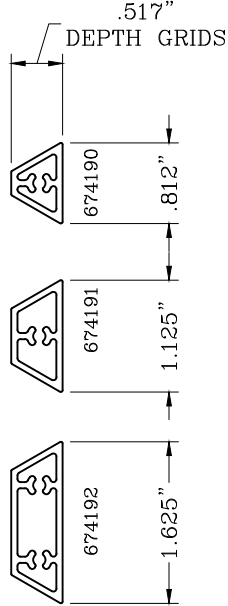

Standard Concave Grids

SR 6700 & GT6... Series
With Concave Glazing Leg

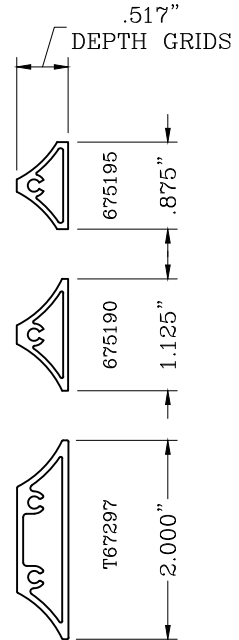

Muntin Grids – Historic Applications

Triple Grid



Series: Accessories Manufacturing Code: GR04

Drawing 1/2 Scale – For Custom Size Drawing Contact Graham

Note: Sealant Not Shown On Details. Refer To General Installation Instructions.

NOTE:

Internal MIG depth may vary and will typically be sized under the external grid and interior flat stock.

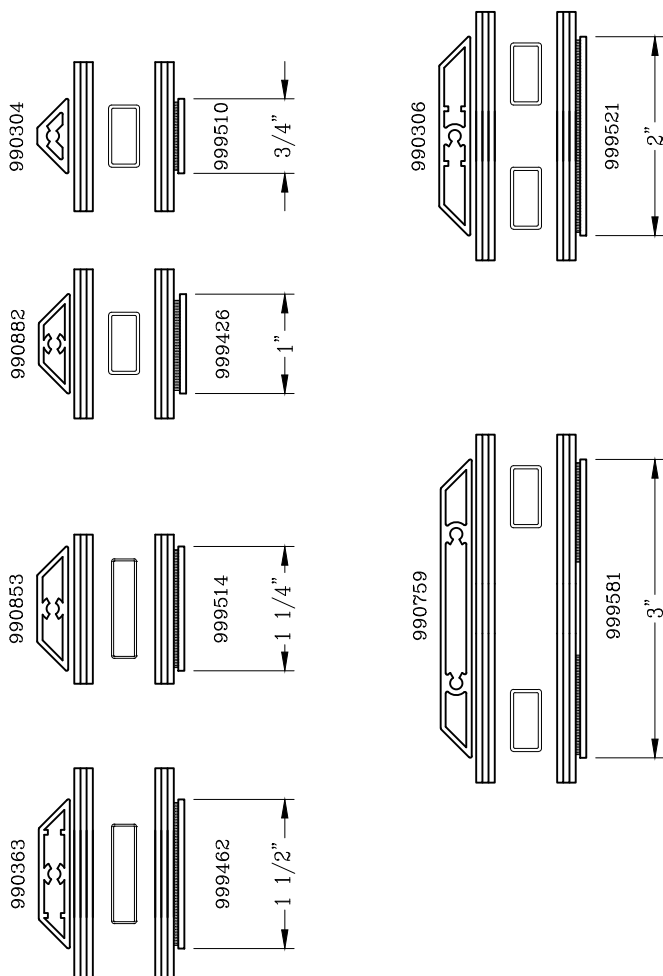
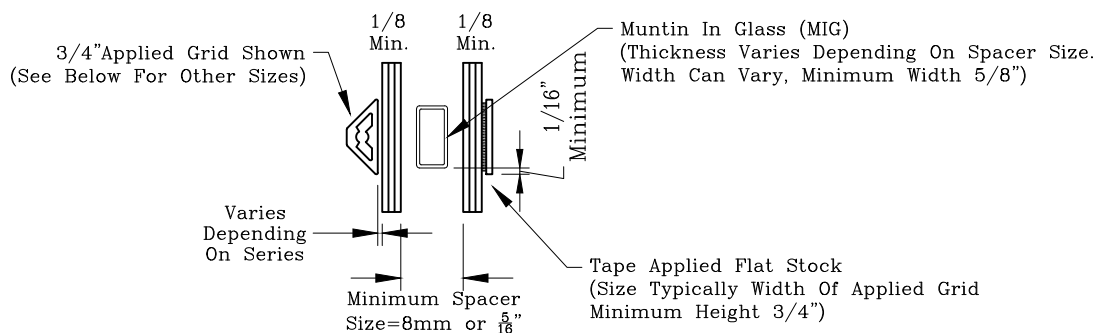

Graham Architectural Products reserves the right to change, add, cancel, remove or otherwise modify the details illustrated without prior notice.

1551 Mt. Rose Avenue, York, Pennsylvania 17403-2909 717.849.8100 Toll Free: 800/755-6274

0524 – GR.04

Web Site: www.grahamwindows.com

Muntin Grids – Historic Applications

Triple Grid



Series: Accessories Manufacturing Code: GR05

Drawing 1/2 Scale – For Custom Size Drawing Contact Graham

Note: Sealant Not Shown On Details. Refer To General Installation Instructions.

Standard Grids

GT2200 Single Hung & 1400 Fixed Offset

Beveled

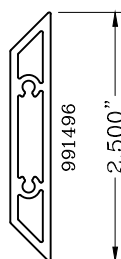
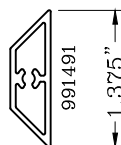
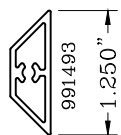
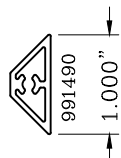
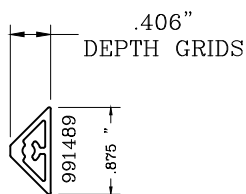

Profile

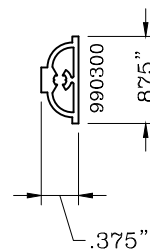
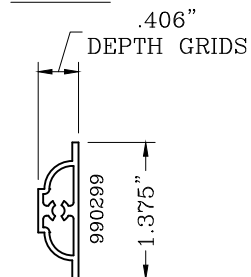

Concave

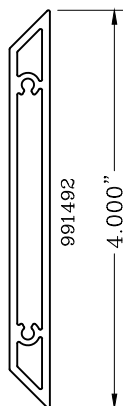
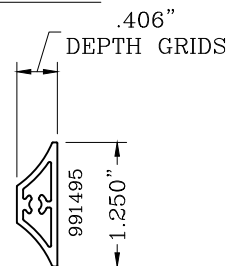

Graham Architectural Products reserves the right to change, add, cancel, remove or otherwise modify the details illustrated without prior notice.

1551 Mt. Rose Avenue, York, Pennsylvania 17403-2909 717.849.8100 Toll Free: 800/755-6274

0524 – GR.05

Web Site: www.grahamwindows.com

Muntin Grids – Historic Applications

Triple Grid



Series: Accessories Manufacturing Code: GR06

Drawing 1/2 Scale – For Custom Size Drawing Contact Graham

Note: Sealant Not Shown On Details. Refer To General Installation Instructions.

NOTE:

Internal MIG depth may vary and will typically be sized under the external and interior grids.

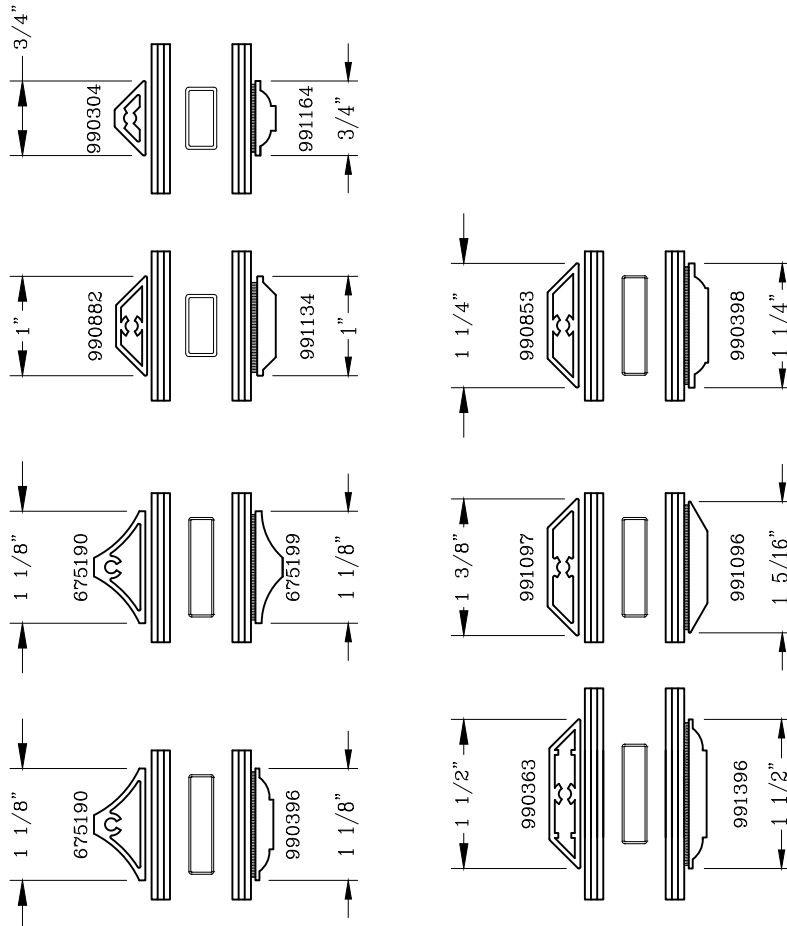
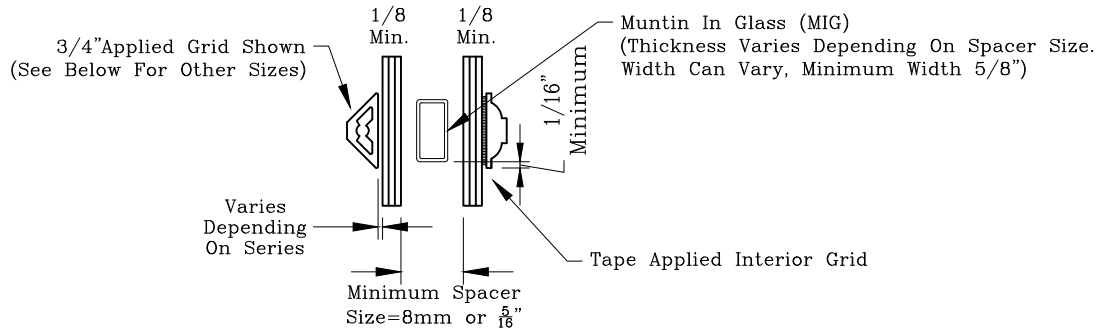

Graham Architectural Products reserves the right to change, add, cancel, remove or otherwise modify the details illustrated without prior notice.

1551 Mt. Rose Avenue, York, Pennsylvania 17403-2909 717.849.8100 Toll Free: 800/755-6274

0223 – GR.06

Web Site: www.grahamwindows.com